

BatteryMINDER®

**12-Volt 128CEC2-AA-S2, S3 & S5 &
24-Volt 244CEC2-AA-S2, S3 & S5**

Aviation-Calibrated Maintenance Charger-Desulfator

INSTRUCTION MANUAL



BATTERY TYPE	RECOMMENDED CHARGER MODEL	
CONCORDE FLOODED	S2	S5
GILL FLOODED	S2	
CONCORDE SEALED RG	S5	
HAWKER-ODYSSEY	S3	
GILL LT/7000	S3	

All Models Include:

- ATS Temperature Sensor (installed)
- Insulated fused 15 Amp Battery Clip cordset (BCAA) with quick connect plug



Intertek
4006773

CONFORMS TO UL
STD. 1236 AND UL
STD. 1012
CERTIFIED TO CSA
STD. C22.2 NO. 107.2

IMPORTANT: Maximum performance and extended battery life require full-time continuous maintenance and desulfation. We recommend the BatteryMINDER BM-AIK2 Airframe Interface Kit for use with FAA-Certified Aircraft or the BatteryMINDER RTA-2415EXP Connection for Experimental Aircraft (purchased separately) for the safest most effective means of connecting your BatteryMINDER to your aircraft's installed batteries (see Page 21 for more details).

**READ AND SAVE THESE
INSTRUCTIONS**

BatteryMINDers.com

Table Of Contents

Glossary of Terms	2
Required Safety Instructions	3 - 7
Preparing to Charge	5
Charger Location.	5
DC Connection Precautions	5
Qualifying Your Battery	7
Specific Gravity – Capacity Table.	7
Testing a Filler Cap Lead-Acid Battery	8
Testing With a Hot/Cold Calibrated Hydrometer Tester	8
Testing a Sealed, AGM or GEL Lead Acid Battery	9
Simplified Operating Instructions	10
Detailed Specifications	10
Common Features	11
Common Features Details	12 - 13
Charging Stages	13
All Unit Labels and Descriptions	14 - 15
LED Indication Table	16
LED Indicator Lights Details	16 - 17
Load Light Table	17
Detailed Operating Instructions	18 - 20
OCV/Battery State of Charge Table	19
Charging a Battery in a Tightly Confined Area	20 - 21
Maintaining Multiple Batteries	22 - 23
Charge and Float Voltages at Various Temperature Ranges	23 - 24
Troubleshooting	25
Multi-Battery Configuration	26
Recommended Accessories (optional)	26
For Repair or Replacement / Registration	27
Guarantee/Warranty	28

Glossary of Terms

- **Maintain a battery**
BatteryMINDer ensures batteries are truly fully charged and will likely continue improving the condition of the battery to the fullest extent possible.
- **Rested**
A battery that has been as fully charged as possible and left disconnected from charger or any type load overnight.
- **Specific Gravity**
One of the key parameters of battery operation is the specific gravity of the electrolyte. Specific gravity is the ratio of the weight of a solution to the weight of an equal volume of water at a specified temperature. Specific gravity is used as an indicator of the state of charge of a cell or battery.
- **Sulfation**
Occurs when the battery sits discharged for a long period of time and large sulfate crystals build up in the plates. The large sulfate crystals increase the resistance of the plates and makes the battery harder to recharge and reduces the amount of power that can be drawn from the battery.

IMPORTANT SAFETY INSTRUCTIONS - SAVE THESE INSTRUCTIONS

This manual contains important safety and operating instructions for all BatteryMINDer battery chargers unless otherwise specified.

A. WARNING: RISK OF EXPLOSIVE GASES

WORKING IN VICINITY OF A LEAD-ACID BATTERY IS DANGEROUS. BATTERIES GENERATE EXPLOSIVE GASES DURING NORMAL BATTERY OPERATION. FOR THIS REASON, IT IS OF UTMOST IMPORTANCE THAT YOU FOLLOW THE INSTRUCTIONS ON (1) BATTERY CHARGER, (2) BATTERY AND (3) PRODUCT USING BATTERY EACH TIME YOU USE THE CHARGER.

1. To reduce risk of battery explosion, follow these instructions and those published by manufacturer of any equipment you intend to use in vicinity of battery. Review cautionary marking on these products and on engine.
2. To reduce risk of injury, charge only lead acid type rechargeable batteries. Other types of batteries may burst causing personal injury and damage.
3. Do not expose charger to rain or snow.
4. Use of an attachment not recommended or sold by VDC Electronics may result in a risk of fire, electric shock, or injury to persons.
5. To reduce risk of damage to electric plug and cord, pull by plug rather than cord when disconnecting charger. Make sure cord is located so that it will not be stepped on, tripped over, or otherwise subjected to damage or stress.
6. An extension cord should not be used unless absolutely necessary. Use of improper extension cord could result in a risk of fire and electric shock. If an extension cord must be used, make sure:
 - a. That pins on plug of extension cord are the same number, size, and shape as those of plug on charger;
 - b. Not to operate charger with damaged cord or plug – replace the cord or plug immediately.
 - c. That extension cord is properly wired and in good electrical condition; and
 - d. That wire size is large enough for AC ampere rating of charger as specified in **Recommended Minimum AWG Size Table**.

Recommended Minimum AWG size for Extension Cords For Battery Chargers					
AC input rating, amperes		AWG size of cord			
Equal to or greater than	But less than	Length of cord, feet			
		18	18	18	16
0	2	25	50	100	150

- e. Do not operate charger with damaged cord or plug – replace the cord or plug immediately.
- f. Do not operate charger if it has received a sharp blow, been dropped, or otherwise damaged in any way.
7. Do not disassemble charger; call VDC Electronics Tech Support Dept. 800.379.5579 x6 (ET) for advice when service or repair is required. Incorrect reassembly may result in a risk of electric shock or fire.
8. To reduce risk of electric shock, unplug charger from outlet before attempting any maintenance or cleaning.

B. PERSONAL PRECAUTIONS

1. Consider having someone close enough by to come to your aid when you work near a lead-acid battery.
2. Have plenty of fresh water and soap nearby in case battery acid contacts skin, clothing, or eyes.
3. Wear complete eye protection and clothing protection. Avoid touching eyes while working near battery.
4. If battery acid contacts skin or clothing, wash immediately with soap and water. If acid enters eye, immediately flood eye with running cold water for at least 10 minutes and get medical attention immediately.
5. NEVER smoke or allow a spark or flame in vicinity of battery or engine.
6. Be extra cautious to reduce risk of dropping a metal tool onto battery. It might spark or short-circuit battery or other electrical part that may cause explosion.
7. Remove personal metal items such as rings, bracelets, necklaces, and watches when working with a lead-acid battery. A lead-acid battery can produce a short-circuit current high enough to weld a ring or the like to metal, causing a severe burn.
8. Use charger for charging a LEAD-ACID battery only. It is not intended to supply power to a low voltage electrical system other than in a starter-motor application. Do not use battery charger for charging dry-cell batteries that are commonly used with home appliances. These batteries may burst and cause injury to persons and damage to property.

9. NEVER charge a frozen battery or a battery at a temperature above 123° F.

Always follow battery manufacturer's strict instructions for proper care, charging and testing of battery. Always use their FAA Approved "Instructions for Continued Airworthiness" (ICA). Questions relating to the subject should be referred directly to the battery manufacturer to be certain of current requirements that may have been added to or changed since publication of their instructions.

C. PREPARING TO CHARGE

1. If necessary to remove battery from vehicle to charge, always remove grounded terminal from battery first. Make sure all accessories in the vehicle are off, so as not to cause an arc.
2. Be sure area around battery is well ventilated while battery is being charged.
3. Clean battery terminals. Be careful to keep corrosion from coming in contact with eyes.
4. Add distilled water in each cell until battery acid reaches level specified by battery manufacturer. Do not overfill. For a battery without removable cell caps, such as valve regulated lead acid batteries, carefully follow manufacturer's recharging instructions.
5. Study all battery manufacturer's specific precautions while charging and recommended rates of charge.
6. Determine voltage of battery by referring to your owner's manual and make sure it matches output rating of battery charger.

D. CHARGER LOCATION

1. Locate charger as far away from battery as DC cables permit.
2. Never place charger directly above battery being charged; gases from battery will corrode and damage charger.
3. Never allow battery acid to drip on charger when reading electrolyte specific gravity or filling battery.
4. Do not operate charger in a closed-in area or restrict ventilation in any way.
5. Do not set a battery on top of charger.
6. Always mount units in vertical position with cord sets exiting downward

E. DC CONNECTION PRECAUTIONS

1. Connect and disconnect DC output clips only after removing AC cord from electric outlet. Never allow clips to touch each other.
2. Attach clips to battery and chassis as indicated in Section G.

**F. FOLLOW THESE STEPS WHEN BATTERY IS INSTALLED IN VEHICLE.
A SPARK NEAR BATTERY MAY CAUSE BATTERY EXPLOSION.**

TO REDUCE RISK OF A SPARK NEAR BATTERY:

1. Position AC and DC cords to reduce risk of damage by hood, door, or moving engine part.
2. Stay clear of fan blades, belts, pulleys, and other parts that can cause injury to persons.
3. **Always connect unit to battery BEFORE plugging into AC POWER SOURCE.**
4. Check polarity of battery posts. POSITIVE (POS, P, +) battery post usually has larger diameter than NEGATIVE (NEG, N, -) post.
5. Determine which post of battery is grounded (connected) to the chassis. If negative post is grounded to chassis (as in most vehicles), see (5). If positive post is grounded to the chassis, see (6).
6. For negative-grounded vehicle, connect POSITIVE (**RED**) clip from battery charger to POSITIVE (POS, P, +) ungrounded post of battery. Connect NEGATIVE (BLACK) clip to vehicle chassis or engine block away from battery. Do not connect clip to carburetor, fuel lines, or sheet-metal body parts. Connect to a heavy gage metal part of the frame or engine block.
7. For positive-grounded vehicle, connect NEGATIVE (BLACK) clip from battery charger to NEGATIVE (NEG, N, -) ungrounded post of battery. Connect POSITIVE (**RED**) clip to vehicle chassis or engine block away from battery. Do not connect clip to carburetor, fuel lines, or sheet-metal body parts. Connect to a heavy gage metal part of the frame or engine block.
8. When disconnecting charger, disconnect AC cord, remove clip from vehicle chassis, and then remove clip from battery terminal.
9. See operating instructions for length of charge information.

**G. FOLLOW THESE STEPS WHEN BATTERY IS OUTSIDE VEHICLE. A
SPARK NEAR THE BATTERY MAY CAUSE BATTERY EXPLOSION.
TO REDUCE RISK OF A SPARK NEAR BATTERY:**

1. Check polarity of battery posts. POSITIVE (POS, P, +) battery post usually has a larger diameter than NEGATIVE (NEG, N, -) post.
2. Attach at least a 24-inch-long 6-gauge (AWG) insulated battery cable to NEGATIVE (NEG, N, -) battery post.
3. Connect POSITIVE (**RED**) charger clip to POSITIVE (POS, P, +) post of battery.

4. Position yourself and free end of cable as far away from battery as possible – then connect **NEGATIVE (BLACK)** charger clip to free end of cable.
5. Do not face battery when making final connection.
6. When disconnecting charger, always do so in reverse sequence of connecting procedure and break first connection while as far away from battery as practical.

QUALIFYING YOUR BATTERY:

Preliminary Requirements

NOTE: The BatteryMINDer has no electrical output unless it is connected to a battery that is not completely dead. Testing the BatteryMINDer with a volt or an Amp meter without the unit being connected across a good battery will result in a false reading. If you experience any problems, or are not

Specific Gravity	State of Charge Level
1.270 (4 Balls floating)	100%
1.250 (3 Balls floating)	75%
1.190 (2 Balls floating)	50%
1.150 (1 Balls floating)	25%
1.120 (0 Balls floating)	Discharged

sure of how to properly use or connect your BatteryMINDer, please e-mail our technical support at: techsupport@vdcelectronics.com or call our toll-free technical support line 800-379-5579 x6 (M - F, ET 9 - 5). **Be certain to leave your phone number with the area code, time zone and the best time to call.** To gain the best result from your new charger and to maximize the life and performance of your batteries we strongly recommend you qualify (test) your batteries before attempting to either charge-maintain or desulfate them. Remember, even if you just purchased a “new” battery it may have been subjected to conditions that have caused “sulfation” such as high temperature ($\geq 80^{\circ}\text{F}$).

NOTE: If your battery is new and you are certain it was not subject to conditions that could have caused sulfation (such as high temperature storage ($\geq 80^{\circ}\text{F}$) and/or allowed to self-discharge to **12.4 Volts / 24.8 Volts** or lower), **even before you purchased it, then you can disregard our recommendations for qualifying / testing your battery, before using the BatteryMINDer.**

Testing a Filler Cap or Manifold-type Lead Acid Battery

1. Carefully remove all caps from your battery.
2. Check the water-liquid electrolyte level. If the level is low or has ever been below top of plates, severe lead plate sulfation has taken place. Significant recharge/reconditioning time is needed to restore these plates to a condition where the battery can be expected to function normally.
3. Refill each cell with distilled water only to the liquid level indicator found in each cell. **Before proceeding further you must be thoroughly familiar with the safety and operating instructions.**
4. Recharge the battery with the BatteryMINDer to ensure that it is slowly and completely charged before you determine its condition. Allow battery to “rest” (see *Glossary of Terms* on page 2) overnight for a minimum of 12 hours before testing with a temperature compensated hydrometer and/or digital type voltmeter only.

Testing with a Hot/Cold Calibrated Hydrometer Tester

Read the tester instructions carefully for most accurate readings.

1. When using the tester the first time or after a long period of non-use, fill the tester with the battery fluid and let it sit for 1/2 hour or longer. This will soak the balls in order to give you more accurate readings. Failure to do so will give you false readings indicating a battery that may not be in as good a condition as you may have thought.
2. After inserting the tester in a cell, gently tap the tester several times against the inside wall of each cell to dislodge air bubbles that will cause more balls to float than should. Failure to do so will yield false readings that indicate a battery that is not fully desulfated or does not qualify for desulfation.
3. If no balls float in any cell, the cell is shorted. This means your battery is beyond the point of being properly recharged or reconditioned/desulfated. Dispose of the battery.
4. If each cell floats three (3) or more balls (or 1250 on gauge-type), your battery can be desulfated/reconditioned.
5. Always rinse the tester with fresh water after every use. Failure to do so will cause false readings.

Testing a Sealed, AGM or GEL Lead Acid Battery

These batteries have no filler caps or manifold-type covers. Because you cannot gain access to the interior of your battery you cannot test it with a hydrometer. **USE A DIGITAL VOLTMETER ONLY:**

1. Recharge the battery with the BatteryMINDer to ensure it is as completely charged as possible, before you determine its condition. Allow battery to “rest” overnight for a minimum of 12 hours before testing with a digital voltmeter only. Failure to test a “rested” battery will cause false readings. Be certain to read and understand all safety related instructions (pages 3 - 7) before proceeding further.
2. Measure battery’s voltage, without any load attached. If the voltage is less than **12.4 volts / 24.8 volts** (Typically 50% of charge) the battery may be too heavily sulfated to be fully recoverable. If voltage is **12.4V / 24.8V** or higher full recovery can be expected, given sufficient time (average 1-2 weeks for batteries that are heavily sulfated).
3. Connect the BatteryMINDer to the battery. Charge battery to its maximum level. Allow battery to rest for a minimum of 8 hours before retesting. If improvement is seen, continue until battery voltage reaches full capacity level or no further increase is seen. Refer to **Open Circuit No Load Voltage** table.
4. **Note:** Do not expect to completely dissolve sulfate in a day. Long established sulfate will require a longer period to be fully dissolved. Be patient and you will be rewarded with a “sulfate-free” battery. If not seriously damaged by sulfate, battery has a very good chance of meeting 85% Cap (Airworthy) Test.

SIMPLIFIED OPERATING INSTRUCTIONS

Read and thoroughly understand ALL SAFETY Instructions, pages 3 - 7 including *Preparing to Charge, DC Connection Precautions, Unit Location and Qualifying Your Battery BEFORE* proceeding further.

1. Attach Battery Clips (**8**, supplied), to output cordset of charger (**5**).
2. Attach output to battery terminals:
RED band = Positive +
BLACK band = Negative -.
3. Ambient Temperature Sensor, **ATS-1** comes already installed on the Temperature Sensor input connector (**4**). Do not detach. *The **Ambient Temperature Sensor (ATS-1)** is mandatory when used with all Aviation batteries.*
4. Plug AC power cord (**6**) into a 120 Vac electrical outlet. **Always connect unit to battery before plugging into AC POWER SOURCE.**
5. Observe **POWER GREEN** steady
6. Observe **BATTERY CONNECTION GREEN/RED** LED indicator (**3E**):
 If lit RED, reverse battery connector attachments on battery.

IF IN DOUBT REGARDING ANY OF THE ABOVE, REFER TO **Detailed Operating Instructions, page 18.**

¹ See full instructions if not lit **GREEN**.

Note: None of our aircraft models are designed to function at input voltages above 140 VAC except when combined with a step-down transformer (not supplied).

Detailed Specifications	
Input Voltage:	90 - 140 Vac
Input frequency :	47 - 63 Hz
Output voltage and current:	12V / 8A 24V / 4A
Plastic enclosure material:	UL-94V0 Noryl or PC or PC+ABS
Enclosure Dimension:	Approx. 7.32 in. (186 mm)(L) x 4.88 in. (124 mm)(W) x 2.44 in. (62 mm)(H)
Weight:	Approx. 2.86 lb. (1.3 Kg)
Temperature compensation range	-4°F/-20°C to 122°F/50°C
Operating Humidity range:	0 to 95% RH
Waterproof:	IP65



Common Features (All Models)	
1	MAINTENANCE MODE ONLY button
2	Battery Stage Indicators: Battery Stage Indicators A: Stage 1: Battery Low (Soft-Start) B: Stage 2: Constant Current (Bulk) C: Stage 3: Constant Voltage (Absorption) D: Stage 4: Battery Fully Charged (Maintenance/Float) See Common Features Details Table on next page & Load Light Table , p. 17 for additional information
3	LED Indicators: See Table on next page
4	Temperature Sensor input connector with ATS-1 Ambient Temperature Sensor installed (included)
5	Output cord with quick connect plug
6	Input power cordset
7	Mounting tabs
8	Battery Clip (15 Amp, insulated) BCAA cordset with quick connect plug

Common Features Details (All Models) Con't. from Previous Table		
	Meaning	Action
1 MAINTENANCE MODE ONLY	Maintenance Mode button – Generally used by a VDC Repair Technician when checking float voltage.	Used to skip over automatic charge sequence including the one hour minimum in the absorption stage (2C) putting the unit directly into a 10 minute Battery Test and then into Maintenance mode.
2A SOFT-START VOLTAGE: LOW, REJECTED	Start of charge AMBER STEADY ON = battery fully discharged.	Allow BatteryMINDER to try to restore battery.
	RED FLASHING = Battery voltage is near zero volts.	Battery rejected
2B BULK STAGE	Battery is being Constant Current charged to about 80%.	Allow BatteryMINDER to charge battery.
2C ABSORPTION STAGE	Battery is being Constant Voltage charged to about 95%.	Allow BatteryMINDER to charge battery.
2D MAINTENANCE/ FLOAT MODE	Battery is being topped off to 100%.	Allow BatteryMINDER to maintain and desulfate battery indefinitely.
3A POWER	GREEN STEADY = AC power connected.	None required.
	GREEN FLASHING = ECO mode (no battery connected, very low standby power mode).	
3B BATTERY WEAK	Battery voltage is low at start of charge OR voltage is low after testing stage.	Allow BatteryMINDER to attempt to restore battery if low at start of charge. Replace battery if voltage is low after testing stage.
3C BAD CELL	RED FLASHING = one or more cells of the battery are dead.	Battery must be replaced.
3D DESULFATING	FLASHING = battery is being desulfated.	None required.
3E BATTERY CONNECTION	GREEN STEADY = battery connected properly.	If needed, correct battery connection.
	RED STEADY = battery connect improperly.	

Common Features Details (All Models) <i>Con't. from Previous Table</i>		
3F LOAD	AMBER STEADY = some device is drawing current. BatteryMINDer is putting out max. current in maintenance mode.	Turn off external device if possible.
3G TESTING	BLUE STEADY = test in progress, pause in charging. (Tests to see if battery holds charge.)	None possible.
3H TEMPERATURE COMPENSATION	Meaning: BLUE STEADY = cold temperature compensation being applied. GREEN STEADY = hot temperature compensation being applied.	None required.

Charging Stages

- Maintenance Mode: the CEC2 Aviation BatteryMINDer is fully automatic and after the batteries are fully charged, unit will go into Maintenance Mode by itself. Maintenance Mode Only button should only be used after the batteries are fully charged or after 3 days in charge mode. No need to push this button if unit automatically is in float. Soft-Start is used if a battery's voltage is under 10.5V/21.0V when charging begins. It uses a low constant current to slowly bring up voltage. This prepares a weak or neglected battery for the Constant Current stage.
- Constant Current (sometimes called Bulk) is the main charging stage. The charger puts out a constant current of 8A for 12V and 4A for 24V, its full power. Battery voltage rises until the battery reaches the optimal charging voltage.
- Constant Voltage (sometimes called Absorption) is the second charging stage. The charger regulates the current given to the battery to maintain constant voltage. As the battery nears a full charge, the current needed to maintain this voltage decreases. Once the current falls below a 0.10A change per hour, the stage is complete. It will be in this stage for a minimum of one hour.
- Battery Test is administered by reading your battery voltage while putting the battery under a load for 10 minutes. A voltage of under 12.5V/25.0V indicates a weak battery, under 11.5V/23.0V indicates a shorted cell. The battery is tested at completion of the Constant Voltage stage, and every 12 hours while in Float.
- Float (sometimes called Maintenance) is the charger's long term stage. The charger can and should be left connected indefinitely. This will keep the battery fully charged ensuring no sulfate can form. The charger maintains float voltage using very little power as it actively monitors the battery and adjusts its output several times a second.

AVIATION-CALIBRATED **12V AIRCRAFT BATTERY ONLY**

BatteryMINDER®
Maintenance Charger - Desulfator
Model 128CEC2-AA-S2
12-Volt @ 8 Amp

MAINTENANCE MODE ONLY (Hold for 3 sec.) **PRESS**

VOLTAGE LOW REJECTED



BULK CONSTANT CURRENT



ABSORPTION CONSTANT VOLTAGE



FULL CHARGE



POWER



BATTERY CONNECTION



BATTERY WEAK



LOAD



BAD CELL



TESTING



DESULFATING



TEMPERATURE COMPENSATION



For Sealed or Filler Cap Lead-Acid GA Batteries ONLY - NOT FOR NiCad

BatteryMINDers.com / 800-379-5579 (ET)

128CEC2-AA-S2: Gill (Sealed [non-LT/7000] + Flooded Wet Cell) + Concorde Flooded

AVIATION-CALIBRATED **FOR HAWKER, ODYSSEY & GILL LT 7000 Series**

BatteryMINDER®
Maintenance Charger - Desulfator
Model 128CEC2-AA-S3
12-Volt @ 8 Amp

MAINTENANCE MODE ONLY (Hold for 3 sec.) **PRESS**

VOLTAGE LOW REJECTED



BULK CONSTANT CURRENT



ABSORPTION CONSTANT VOLTAGE



FULL CHARGE



POWER



BATTERY CONNECTION



BATTERY WEAK



LOAD



BAD CELL



TESTING



DESULFATING



TEMPERATURE COMPENSATION



For Sealed or Filler Cap Lead-Acid GA Batteries ONLY - NOT FOR NiCad

BatteryMINDers.com / 800-379-5579 (ET)

128CEC2-AA-S3: Hawker-Odyssey + Gill LT/7000

AVIATION-CALIBRATED **FOR CONCORDE ONLY**

BatteryMINDER®
Maintenance Charger - Desulfator
Model 128CEC2-AA-S5
12-Volt @ 8 Amp

MAINTENANCE MODE ONLY (Hold for 3 sec.) **PRESS**

VOLTAGE LOW REJECTED



BULK CONSTANT CURRENT



ABSORPTION CONSTANT VOLTAGE



FULL CHARGE



POWER



BATTERY CONNECTION



BATTERY WEAK



LOAD



BAD CELL



TESTING



DESULFATING



TEMPERATURE COMPENSATION



For Sealed or Filler Cap Lead-Acid GA Batteries ONLY - NOT FOR NiCad

BatteryMINDers.com / 800-379-5579 (ET)

128CEC2-AA-S5: Concorde (Sealed Valve-Regulated AGM + Flooded Wet Cell)

AVIATION-CALIBRATED **24V AIRCRAFT BATTERY ONLY**

BatteryMINDER®
Maintenance Charger - Desulfator
Model 244CEC2-AA-S2
24-Volt @ 4 Amp

MAINTENANCE MODE ONLY (Hold for 3 sec.) **PRESS**

VOLTAGE LOW REJECTED **BULK CONSTANT CURRENT** **ABSORPTION CONSTANT VOLTAGE** **FULL CHARGE**

POWER **BATTERY CONNECTION**
BATTERY WEAK **LOAD**
BAD CELL **TESTING**
DESULFATING **TEMPERATURE COMPENSATION**

For Sealed or Filler Cap Lead-Acid GA Batteries ONLY - NOT FOR NiCad BatteryMINDers.com / 800-379-5579 (ET)

244CEC2-AA-S2: Gill (Sealed [non-LT/7000] + Flooded Wet Cell) + Concorde Flooded

AVIATION-CALIBRATED **FOR HAWKER, ODYSSEY & GILL LT 7000 Series**

BatteryMINDER®
Maintenance Charger - Desulfator
Model 244CEC2-AA-S3
24-Volt @ 4 Amp

MAINTENANCE MODE ONLY (Hold for 3 sec.) **PRESS**

VOLTAGE LOW REJECTED **BULK CONSTANT CURRENT** **ABSORPTION CONSTANT VOLTAGE** **FULL CHARGE**

POWER **BATTERY CONNECTION**
BATTERY WEAK **LOAD**
BAD CELL **TESTING**
DESULFATING **TEMPERATURE COMPENSATION**

For Sealed or Filler Cap Lead-Acid GA Batteries ONLY - NOT FOR NiCad BatteryMINDers.com / 800-379-5579 (ET)

244CEC2-AA-S3: Hawker-Odyssey + Gill LT/7000

AVIATION-CALIBRATED **FOR CONCORDE ONLY**

BatteryMINDER®
Maintenance Charger - Desulfator
Model 128CEC2-AA-S5
12-Volt @ 8 Amp

MAINTENANCE MODE ONLY (Hold for 3 sec.) **PRESS**

VOLTAGE LOW REJECTED **BULK CONSTANT CURRENT** **ABSORPTION CONSTANT VOLTAGE** **FULL CHARGE**

POWER **BATTERY CONNECTION**
BATTERY WEAK **LOAD**
BAD CELL **TESTING**
DESULFATING **TEMPERATURE COMPENSATION**

For Sealed or Filler Cap Lead-Acid GA Batteries ONLY - NOT FOR NiCad BatteryMINDers.com / 800-379-5579 (ET)

244CEC2-AA-S5: Concorde (Sealed Valve-Regulated AGM + Flooded Wet Cell)

LED INDICATION TABLE			
POWER			GREEN
Green Steady	AC power connected		
Green Flashing	ECO mode		
BATTERY CONNECTION		GREEN	RED
Green Steady	Battery connected correctly		
Red Steady	Battery connected incorrectly		
BATTERY WEAK			AMBER
Amber Steady	Battery requires soft-start charging or battery voltage is < 12.5V / 25.0V after analysis stage		
LOAD			AMBER
Amber Steady	The output current is up to the maximum rating in Float mode		
BAD CELL			RED
Red Flashing	Battery voltage is < 11.5V / 23.0V after analysis stage		
TESTING			BLUE
Blue Steady	Analysis stage		
DESULFATING			BLUE
Blue Flashing	Desulfating pulses are in process		
TEMPERATURE COMPENSATION		GREEN	BLUE
Green Steady	Ambient temperature > 27°C/80°F		
Blue Steady	Ambient temperature < 21°C/70°F		
VOLTAGE LOW	AMBER	REJECTED	RED
Initial qualification of the battery's condition (at the beginning of Soft-Start stage)			
Amber Steady	Voltage: 12 Volt: 3 - 10.5V / 24 Volt: 6 - 21V		
Red Flashing	Voltage: 12 Volt: < 3V / 24 Volt: < 6V (Low Voltage)		

LED Indicator Light Details

- **Power** light is **GREEN** anytime the charger is plugged into AC Power.
- **Battery Connection** light is **GREEN** when the unit it is correctly connected to a battery. If the **Battery Connection** light is **RED** the polarity is reversed. The positive and negative terminals need to be switched or there is a short circuit.
- **Battery Weak** light is **AMBER** if the **Soft-Start** mode is used or the battery fails a Battery Test. The indicator will stay on until the battery passes a Battery Test.

A neglected battery can take over 2 weeks of desulfation to correct. If

after 2 weeks it still reads as a Weak Battery, there is likely internal physical damage.

- **Load** light is **AMBER** if the charger is in Float and outputting full amperage. This indicates a drain on the battery. If possible remove any loads. See Load Light Table below.
- **Bad Cell** if the charger has not completed the **Constant Current** stage in 20 hours and battery voltage is under 11.5V/23.0V, or if the battery is under 11.5V/23.0 after a **Battery Test**.

The charger shuts off output to avoid any damage to your battery. Loads or banks of batteries may trigger this mode if they are too large for this charger. Remove any loads and charge batteries individually.

- **Testing** light flashes **BLUE** when the unit is performing a **Battery Test** (see **Charging Stages**).
- **Desulfation** light flashes **BLUE** any time the unit is desulfating. The BatteryMINDER desulfates any time it is outputting current.
- **Temperature Compensation** light is **GREEN** if the temperature is over 80°F/27°C, **BLUE** if the temperature is under 70°F/21°C. BatteryMINDER CEC models includes an ambient temperature sensor which allows it to vary the output voltage as necessary to properly charge your 12V (-28mV/°C) or 24V (-56mV/°C) battery. Batteries charged at higher temperatures without compensation will overcharge and may out-gas. Batteries charged at lower temperatures without compensation will undercharge allowing sulfation to build, possibly leading to the battery freezing. By using temperature compensation, the BatteryMINDER ensures your battery will never over or under charge, even in extreme conditions.

Load Light Table

128CEC2-AA-S2, -S3 & -S5	
Load Light OFF	
Soft-Start	4A
Constant Current	8A
Load Light ON	
Float (Battery < 11V)	8A
Float (Battery < 12V)	8A
Float (Battery < 13V)	8A
Float (Battery > 13V)	8A

244CEC2-AA-S2, -S3 & -S5	
Load Light OFF	
Soft-Start	2A
Constant Current	4A
Load Light ON	
Float (Battery < 22V)	4A
Float (Battery < 24V)	4A
Float (Battery < 26V)	4A
Float (Battery > 26V)	4A

DETAILED OPERATING INSTRUCTIONS

Installed properly, your charger is set to provide your battery with what it needs to out-live and out-perform any similar battery used in the same application-conditions by a factor of two (2).

Read and thoroughly understand all safety instructions, pages 3 - 7 including *preparing to charge, DC connection precautions, unit location and qualifying your battery before proceeding further.*

1. Attach output cord of charger to the battery clip(s) assembly (**BCAA**) (supplied). **For aviation applications, we no longer advise use of the Ring Terminal Assembly on any batteries while the battery is located within a confined area, such as in an aircraft engine compartment.**
2. **Battery should be removed from aircraft or open to free flowing air to avoid possible build-up of harmful hydrogen gas in the event battery has a shorted cell(s) or charging source is incorrect or malfunctions. You should always refer to your battery manufacturer's recommendations *first and foremost* on charging a battery within the aircraft for further information.**
3. **Note: because some batteries are not easily accessible, for example located in the wing, tail, under the seat or in a battery box, it is acceptable to attach the positive alligator clip to the positive post of the battery relay or solenoid that is directly connected to the positive terminal of the battery and attach the negative alligator clip to a suitable aircraft ground connection. See page 20 for information on charging a battery in a tightly confined area.**
4. Plug the unit's power cord into a standard – grounded 120 VAC electrical outlet. The power on led indicator will light **GREEN**. Within 30 seconds, if it does not light **GREEN** check the outlet to be sure it is functioning. In addition, be sure if outlet is controlled by a switch, no one will accidentally shut off the power to the outlet. Check for correct polarity = (no error **RED** led indicator). If error indicator is lit, reverse the charger's output connections to the battery.

Charger will automatically start within 15 - 30 seconds. The Bulk LED Indicator will light **GREEN**. The charger will now begin charging by first checking the battery to determine its voltage and ability to accept a charge. Should the battery not have a normal fully discharged voltage (10.5V/21.0V minimum) the unit will begin charging in the "Soft-Start" mode to determine if the battery can be safely charged. If it cannot, the Soft-Start LED will light **RED** and charging will be stopped. Battery should be carefully checked under a load by a qualified person before further attempting to charge it.

Note: If the battery does not have a minimum no load OCV (Open Circuit Voltage) of 3/6 volts, the Soft-Start LED will light **RED** and charger will reject battery.

No further effort should be made to charge this battery with this charger or any charger. Discard this battery, unless it has just been subjected to a long period of continuous discharge under a load such as can occur with leaving lights on or cranking an engine excessively. Allow such a battery to “Rest” for several hours (overnight if possible) before determining if it is defective.

Be very suspicious of any 12V/24V battery that does not have at least 11V/22V (OCV) before it is recharged. It may well be seriously damaged and unsafe for any type of use or recharge. The unit’s Battery Weak Indication LED will help you determine if battery is less than 11V/22V (**AMBER**).

- After battery has been fully charged, Float stage LED will light. Battery may not be able to be fully charged, may be too large or too deeply discharged to be fully charged in the normal time allowed by charger. If you are certain battery is not defective, having read and understood completely all of the above concerns and conditions, proceed to reboot the charger by unplugging from the wall (AC), disconnecting from the battery (DC) and waiting 30 seconds before reconnecting the battery and then the AC. This allows charger to begin charging battery again. If battery is not defective it should be able to be fully charged after being restarted. After sufficient time has lapsed the Float stage LED Indicator (**Common Features** table, page 12, item **2D**) will illuminate confirming when / if battery is now fully charged.

Note: If attempting to charge more than one battery at a time, it is very likely

OCV=Open Circuit No Load Voltage		
OCV - “Rested” Voltage		Full Capacity Percentage
12V	24V	
12.9 - 13.1	25.8 - 26.2	100%
12.6 - 12.9	25.2 - 25.8	75%
12.4 - 12.6	24.8 - 25.2	50%
12.2 - 12.4	24.4 - 24.8	25%
12.0 - 12.2	24.0 - 24.4	0%
<11.0 = shorted	<22.0 = shorted	

Note: All OPTIMA brand starter/deep cycle batteries have a fully charged “resting” voltage of 13.1 (OCV). Increase above values accordingly.

the charger will need to be restarted as described in order to completely charge multiple batteries. We do not recommend charging more than one battery at a time. A better solution is to charge each battery separately using your BatteryMINDER and then connect them together, if desired for long term maintenance-float charging. We suggest reading ***MAINTAINING MULTIPLE BATTERIES***, page 22, and the additional LED Indicator Functions, page 16, not already covered above.

IMPORTANT!

Charging a Battery in a Tightly Confined Area

Charging a battery in a tightly confined area should always be avoided as it can be dangerous, especially if battery is, has or was:

1. Older than 2 years
2. Infrequently used without an approved maintenance aviation specific charger being consistently used
3. Marginal at last capacity test
4. Not frequently checked for proper electrolyte level in each cell
5. Ever needed considerable water added, especially in one or more cells vs. other cells needing far less
6. Different Specific Gravity (SG) readings-levels (cell to cell) or has one or more cells reading less than 1.220 after being fully charged, left to "Rest"¹ for a minimum of 12 hours (as we describe repeatedly in all our Instruction Manuals)

¹Rest / Resting = Fully charge battery, then remove charger and any loads connected to battery for a time not less than 8 hours nor more than 12. Measurements must be with a digital (only) type voltmeter and/or a temperature compensated hydrometer unless testing is done at temperatures no higher than 80°F nor lower than 60°F.

We no longer advise use of the Ring Terminal Assembly (RTA) on any battery while battery is located within a confined area, such as in an aircraft engine compartment. Battery should be removed or open to free flowing air to avoid possible build-up of harmful hydrogen gas should battery have a shorted cell(s) or charging source is incorrect or malfunctions. Refer to your battery manufacturer's recommendations on charging a battery within the aircraft for further information.

Because some batteries are not easily accessible, for example, located in the wing, tail, under the seat or in a battery box, it is acceptable to attach the positive alligator clip to the positive post of the battery

relay or solenoid that is directly connected to the positive terminal of the battery and attach the negative alligator clip to a suitable aircraft ground connection.

Consult with the aviation battery manufacturer for further details and specifications important to fully comply with all regulatory authorities.

To achieve maximum performance and extended battery life requires full-time continuous maintenance and desulfation. We recommend the following options for a safe, legal quick-connection harness (sold separately.)



BMAIK2 (A & B)
Airframe Interface Kit For Use with FAA-Certified Aircrafts

For a permanently installed quick-connect charger harness on FAA-certified aircraft, order the optional Model BM-AIK2 Airframe Interface Kit from BatteryMINDers.com. Eligible as a minor alteration, installed by your mechanic. No STC, field approval or Form 337 required. Returned to service by mechanic's log entry.

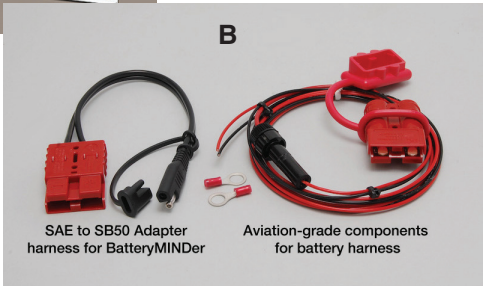
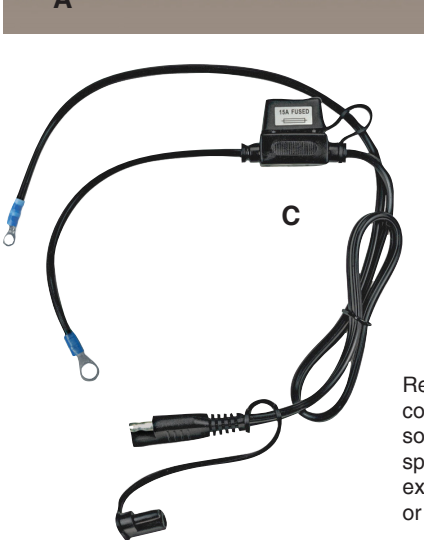

RTA-2415EXP Connection for Experimental Aircraft (C)

Ready-to-use cable assembly provides simple connection to experimental aircraft's master solenoid and airframe ground. SAE plug for aviation-specific BatteryMINDER maintenance chargers. For experimental amateur-built aircraft only. NOT eligible or legal for installation on FAA certified aircraft.

MAINTAINING MULTIPLE BATTERIES

BatteryMINDer Aviation Maintenance-Charger-Desulfators can be used to **maintain** up to two 12-Volt or 24-Volt batteries at a time, providing each battery is fully operational (no dead-dying cells), free of sulfate and meeting the minimum open circuit charge “rested” voltage of 12.7 Volts or 25.4 Volts, after being fully desulfated.

Never connect two or more batteries together unless they are fully charged. ALL batteries MUST be properly tested to ensure they are in good condition (no dead-dying cells or excessive sulfation) before maintaining them in multiples. Only healthy, fully desulfated batteries should ever be MAINTAINED in sets of 2 or more. Check each cell of ALL filler cap batteries using an accurate, temperature compensated hydrometer. Check sealed (no filler caps) batteries using an accurate, DIGITAL type voltmeter, ONLY. The minimum voltage must not be less than 2.1 volts / cell after fully charging battery and letting it “rest” for 12 hours minimum, before testing. If battery voltage is less than 2.1 volts / cell you must first desulfate it until you reach a “rested” voltage of 2.1 volts / cell.

Remember, you must desulfate each battery by itself (one at a time) before maintaining them for extended periods. Attempting to desulfate more than one battery at a time will yield very poor results, as the strongest (healthiest) and not the weakest (most sulfated) battery will receive the majority of the desulfation pulse energy.

ALWAYS test each battery individually to be certain it is healthy and free of sulfate before attempting to charge or maintain them, either as a single battery or in sets. **NEVER connect multiple batteries together for maintenance charging purposes using less than #18 Gauge insulated wire or consider using BatteryMINDer Y-Connector Model 210AY with SmarTECHnology*.**

See diagram on the page 26 for the most common multiple battery configuration.

*BatteryMINDer® has developed a simple, safe and inexpensive method of connecting multiple batteries they call SmarTECHnology®-Y. Using their single SmarTECHnology®-Y connector, two batteries can be maintained simultaneously using just a single output charger designed to maintain batteries. Adding additional Y-connectors allows from four (4) to eight (8) batteries to be connected depending on the maintenance charger capability.

The chart below shows the need to regulate the output voltage of the 12V charger to ensure against over or under charging your battery over a wide range of temperatures. Using your Ambient Temperature Sensor (**ATS-1**) will accomplish this better than any other known method.

12 VOLT (128CEC2-AA-S2, S3 & S5) Charge and Float Voltages at Various Temperatures							
Temp F°	Optimum Charge Voltage			Optimum Float Voltage			Temp C°
	-S2	-S3	-S5	-S2	-S3	-S5	
≥ 122	13.40	14.00	13.88	13.05	13.20	13.00	≥ 50
113	13.54	14.14	13.92	13.05	13.20	13.02	45
104	13.68	14.28	13.97	13.05	13.20	13.07	40
95	13.82	14.42	14.01	13.05	13.20	13.11	35
86	13.96	14.56	14.06	13.05	13.20	13.16	30
77	14.10	14.70	14.10	13.05	13.20	13.20	25
68	14.24	14.84	14.24	13.19	13.34	13.34	20
59	14.38	14.98	14.38	13.33	13.48	13.48	15
50	14.52	15.12	14.52	13.47	13.62	13.62	10
≤ 41	14.66	15.26	14.66	13.61	13.76	13.76	≤ 5

The chart below shows the need to regulate the output voltage of the 24V charger to ensure against over or under charging your battery over a wide range of temperatures. Using your Ambient Temperature Sensor (**ATS-1**) will accomplish this better than any other known method.

24 VOLT (244CEC2-AA-S2, S3 & S5) Charge and Float Voltages at Various Temperatures							
Temp F°	Optimum Charge Voltage			Optimum Float Voltage			Temp C°
	-S2	-S3	-S5	-S2	-S3	-S5	
≥ 122	26.80	28.00	27.75	26.10	26.40	26.00	≥ 50
113	27.08	28.28	27.84	26.10	26.40	26.04	45
104	27.36	28.56	27.93	26.10	26.40	26.13	40
95	27.64	28.84	28.02	26.10	26.40	26.22	35
86	27.92	29.12	28.11	26.10	26.40	26.31	30
77	28.20	29.40	28.20	26.10	26.40	26.40	25
68	28.48	29.68	28.48	26.38	26.68	26.68	20
59	28.76	29.96	28.76	26.66	26.96	26.96	15
50	29.04	30.24	29.04	26.94	27.24	27.24	10
≤ 41	29.32	30.52	29.32	27.22	27.52	27.52	≤ 5

After carefully reading these instructions and Troubleshooting (page 25) sections, should you still have questions, please e-mail our technical support department at: techsupport@vdcelectronics.com. Allow up to 3 business days for a detailed response to your questions. Always identify the model number of the product and revision letter of this manual contained on this page below. Without this information we may not be able to assist you correctly.

TROUBLESHOOTING GUIDE

PROBLEM	POSSIBLE CAUSE	SOLUTION
Power ON Indicator does not light after being plugged into AC for 30 seconds.	AC outlet is dead.	Plug in a lamp or other appliance to check for voltage. If controlled by a wall switch, be sure switch is on and try to prevent accidental shut off while charger is working.
Battery Connection Indicator lights RED solid .	Output lead connections to battery may be reversed.	Switch (reverse) connections at battery.
VOLTAGE Indicator lights RED blinking . (Common Features table, page 12, item 2A).	Battery voltage <3/6 volts.	Battery may be damaged and should not be recharged. Allow battery to “recover” by letting it “rest” without a load.
	Battery was just recently removed from a load (lights, electronic equipment) or not used for extended time without a charger-maintainer.	If battery is healthy and just deeply discharged it should recover its voltage (rise above 3/6 volts) sufficiently to allow charger to begin an attempt to fully recharge it.
	Battery has “rested” and still cannot be recovered – recharged.	Battery should be safely discarded – recycled.
Battery Weak Indicator lights AMBER solid . (Before battery has been completely charged).	Battery(s) may be weak, heavily sulfated, or too large to fully charge before unit times out.	
	Battery may be so large it may require a second full recharge.	Reboot unit by unplugging from A.C. electrical outlet, disconnect from battery so there will be no electrical power going to the unit from either direction, wait 30 seconds, connect to battery first then plug into A.C. outlet.
	Battery can be weak due to sulfation, self discharge or was very deeply discharged.	Attempt a full recharge and recheck after completion. If still AMBER , follow next procedure (“After battery has been completely charged.”)

OPTIONAL ACCESSORIES



MULTI-BATTERY CONFIGURATION

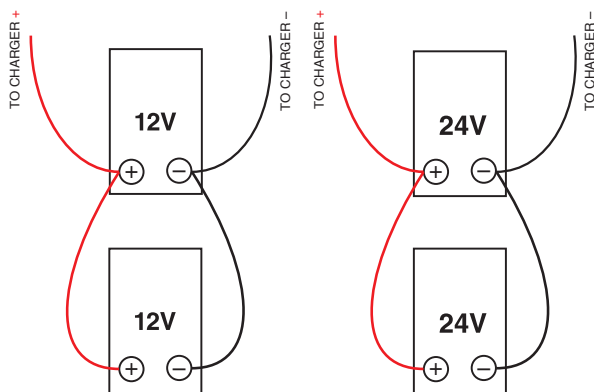

BC2AY: Insulated Battery Clips paired with 210AY Y-Connector with SmarTECHnology®

210AY Y-Connector with SmarTECHnology®



One BatteryMINDER Will Maintain Two Batteries Using a BCAA (included) + BC2AY* Accessory

FOR REPAIR OR REPLACEMENT

All returns must be authorized by VDC Electronics.

In the event that you believe your product may be defective, you **MUST** speak to a VDC Electronics technician at **1-800-379-5579 x6** (M - F, ET) before proceeding further. If you must return the unit, the technician will give you an **RMA #**. Please use Return Form found on batteryinders.com/ under **Shipping & Returns** when returning your product.

IMPORTANT NOTICE

BatteryMINDER® Five-Year Warranty Registration
BatteryMINDers.com/ under **Registration**

Please register your unit on-line within 10 days of purchase. **Due to the ever-changing technology associated with this BatteryMINDER® unit, we may be unable to keep you informed of significant upgrades, changes, etc. without your registration.** The information you provide upon registration will be used to keep a record of your purchase and will assist in providing support should you ever need to contact our Technical Service department:
techsupport@vdcelectronics.com; 800-379-5579 x6 (ET).

BatteryMINDER Model **128CEC2-AA** or **244CEC2-AA**

-S2

-S3

-S5

Serial Number _____

Place of purchase _____

Date of purchase _____

RMA# _____

NOTES

BatteryMINDer® Guarantee and Warranty Policy effective Jan. 2013.

ALL Returns and Replacements must be authorized by a VDC Electronics technician. Units must only be returned to VDC Electronics, Inc., NOT TO THE DEALER FROM WHOM IT WAS PURCHASED.

For ALL Replacements, Returns or Repairs covered by Guarantee or Warranty:

Please call **800-379-5579 x6**, M - F, 9 AM - 5 PM (ET) to speak to a technician. Have your unit available when you call. We will ask you for:

Your contact information	Product serial number	Proof of purchase
--------------------------	-----------------------	-------------------

One-Year 100% Unconditional Money Back Guarantee:

Your BatteryMINDer product is guaranteed within the first year to perform as claimed or VDC Electronics, Inc. will refund your full purchase price including all taxes, shipping or handling cost applicable to the purchase. Customer will return product to VDC Electronics at their expense.

The Technician will provide you with an RMA number and shipping information. You will be required to fill out a form to complete your return which can be found on BatteryMINDers.com, see Shipping/Returns. Clearly write your RMA number on the outside of the package you are returning. We suggest using a carrier that provides tracking information. VDC Electronics is not responsible for returned packages lost in transit. If the unit is to be replaced, it is shipped by ground with free shipping. Expedited shipping is available at extra cost.

Five-Year Limited Warranty:

Your BatteryMINDer product is warrantied for FIVE years from date of purchase at retail against defective material or workmanship. We make no warranty other than this limited warranty and expressly exclude any implied warranty including any warranty for consequential damages. This limited warranty is not transferable.

- If the technician determines defective unit should be **repaired**, customer will return product at their expense. Once we receive the unit it will be repaired and shipped back to customer, all at no charge. Expedited shipping is available at extra cost.
- If the technician determines unit does not warrant repair but needs **replacement**, customer will be required to pay a \$9.95 shipping fee for the replacement unit. This fee may be subject to change without notice. There is no cost for the replacement unit itself. Expedited shipping is available at extra cost.

**VDC Electronics, Inc.
155 W. Carver St., Ste. 2
Huntington, NY 11743
www.BatteryMINDers.com
techsupport@vdcelectronics.com**